

Article number: 03206025

Description: Fluro Rod End GALXS 25
Zinc Plated with left-handed thread

Measures

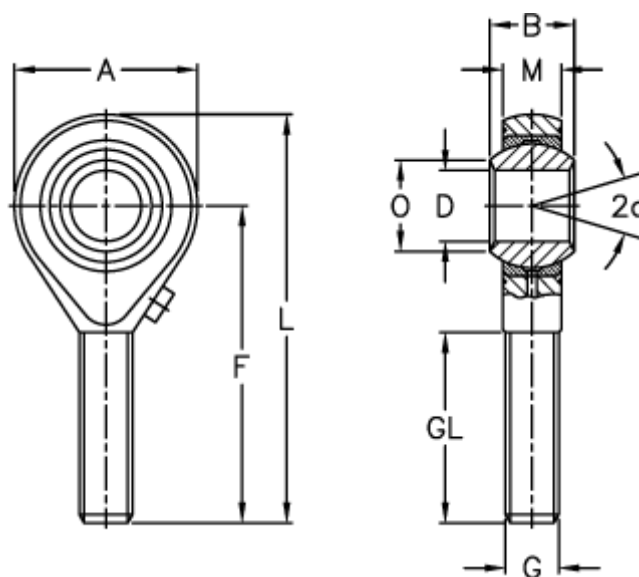

A	= 60	L	= 124
a (degrees)	= 15	M	= 22
B	= 31	O	= 29.6
D	= 25	Permissible rpm	= 440
Dynamic load C (kN)	= 47	Static load C0 (kN)	= 135
F	= 94	Weight (g)	= 600
g	= M24x2		
GL	= 58		